

Iskra PNZ11Z Series presets

Order Code	Manufacturers Part No	Description
545-001	PNZ11Z100E	100R Vertical preset
545-002	PNZ11Z220E	220R Vertical preset
545-003	PNZ11Z470E	470R Vertical preset
545-004	PNZ11Z1K	1K Vertical preset
545-005	PNZ11Z2K2	2K2 Vertical preset
545-006	PNZ11Z4K7	4K7 Vertical preset
545-007	PNZ11Z10K	10K Vertical preset
545-008	PNZ11Z22K	22K Vertical preset
545-009	PNZ11Z47K	47K Vertical preset
545-010	PNZ11Z100K	100K Vertical preset
545-011	PNZ11Z220K	220K Vertical preset
545-012	PNZ11Z470K	470K Vertical preset
545-013	PNZ11Z1M	1M Vertical preset

RoHS compliant

The enclosed information is believed to be correct. Information may change without notice due to product improvement. Check to ensure that the product is suitable for the intended application. E. and O.E

Telephone **01737 841568**
FAX **01737 841608**
Email technical@electronelec.co.uk
Web www.electronelec.co.uk



Miniature Types For Printed Circuits / Ser.PNZ / 10 mm

Technical data

Rated dissipation at $\vartheta_{amb}= 40^{\circ}\text{C}$	lin 0.15W / log 0.10W
Resistance value range	lin 100 Ω to 10 M Ω / log 1k Ω to 2 M Ω
Maximum voltage	lin 200 V dc / log 150 V dc
Electric angle of rotation	240 $^{\circ}\pm 20^{\circ}$
Mechanical angle of rotation	295 $^{\circ}\pm 5^{\circ}$
Operating torque	4 to 20 mNm
End stop torque	≥ 50 mNm
Weight PNZ10Z, PNZ11Z	0.72 g

PNZ10Z

"snap-in" version

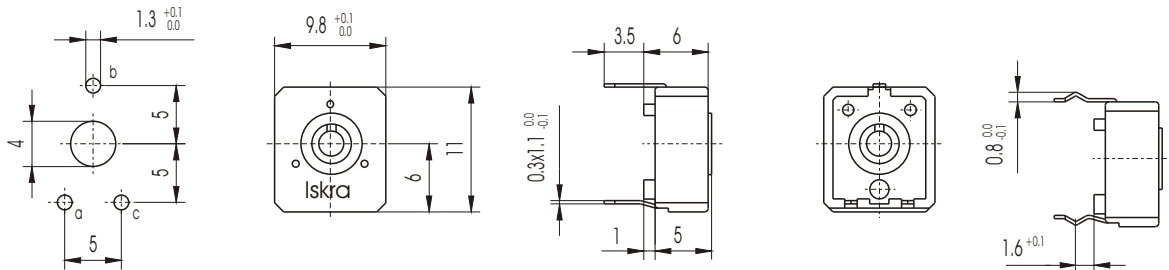

PNZ11Z

"snap-in" version

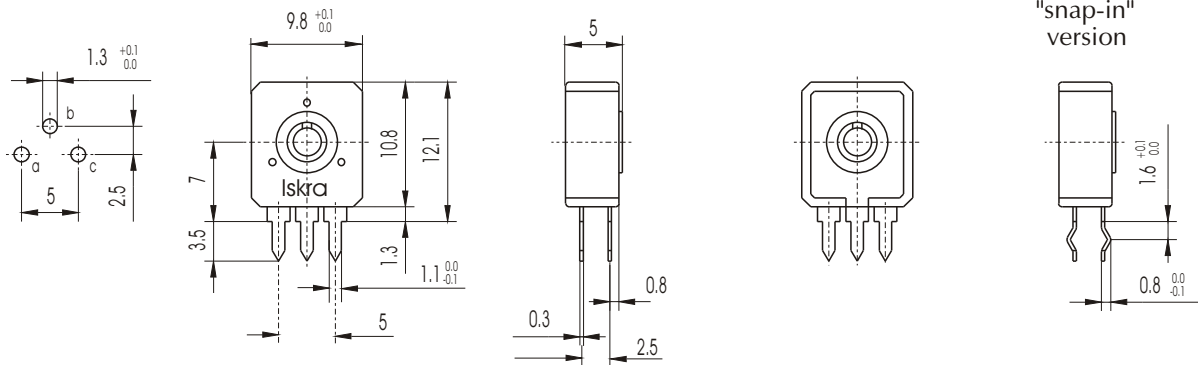

Accessories / Ser. PNZ - PNCZ / 10mm

ADJUSTMENT SLOT

PNZ10Z, PNZ11Z, PNCZ10Z, PNCZ11Z potentiometers adjustment slots shown in middle pot position

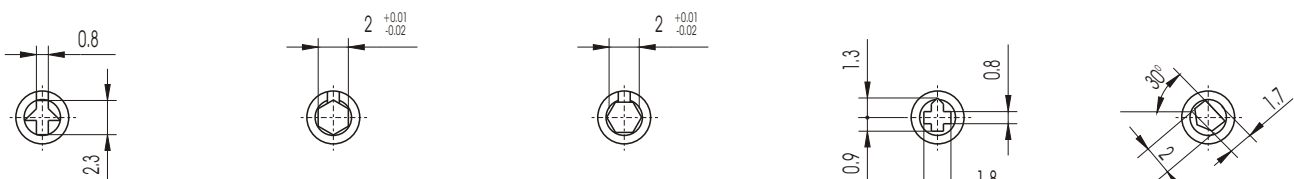

PNZ...

PNZ...A

PNZ...AU

PNZ...B

PNZ...C



THUMBWHEEL

PNZ10ZA, PNZ11ZA, PNCZ10ZA, PNCZ11ZA potentiometers thumbwheel

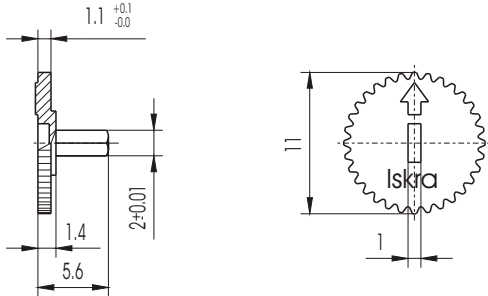

Thumbwheel Colour	Code
White	88 131 162
Black	88 131 393
Red	88 131 406
Blue	88 131 751
Green	88 131 560

PNZ10ZA, PNZ11ZA, PNCZ10ZA potentiometers shaft (STYLE1)

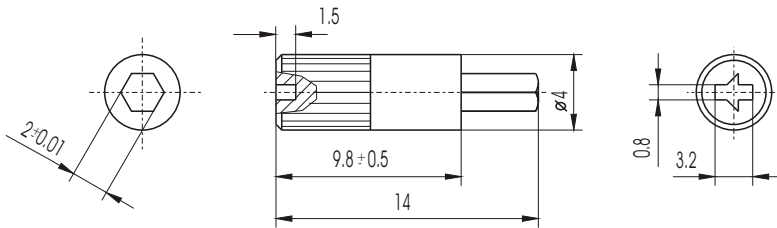

Shafts Colour	Code
White	88 131 161
Black	88 131 387
Red	88 131 490
Blue	88 131 598

PNZ10ZA, PNZ11ZA, PNCZ10ZA, PNCZ11ZA potentiometers shaft (STYLE 2)

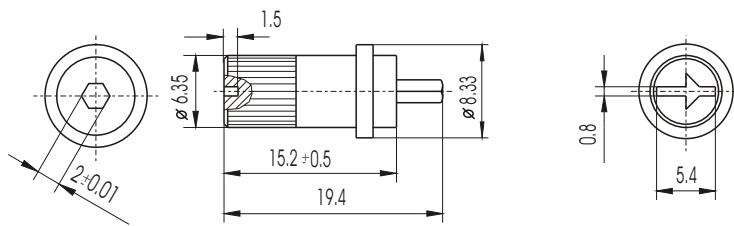

Shafts Colour	Code
White	88 131 446
Black	88 131 489
Red	88 131 502

PNZ10ZA, PNZ11ZA, PNCZ10ZA, PNCZ11ZA potentiometers shaft (STYLE 3)

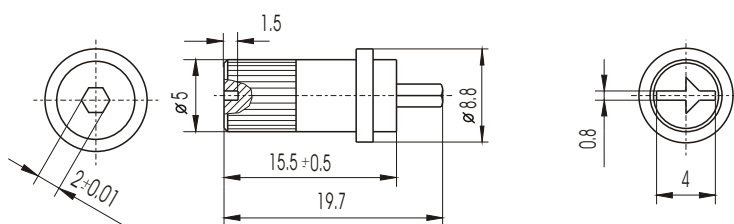

Shafts Colour	Code
White	88 131 544
Black	88 131 589
Red	88 131 776



Packaging / Ser. PNZ - PNCZ / 10mm

Potentiometers PNZ10Z PNCZ10Z are packaged in plastic tubes, compatible with automatic assembly equipment.

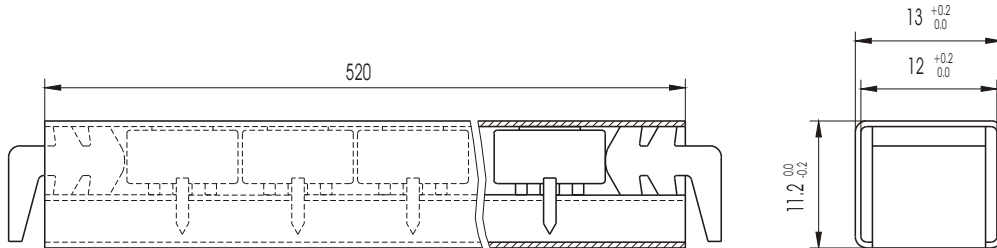

50 pcs

Ordering Example / Ser. PNZ / 6mm, 10mm

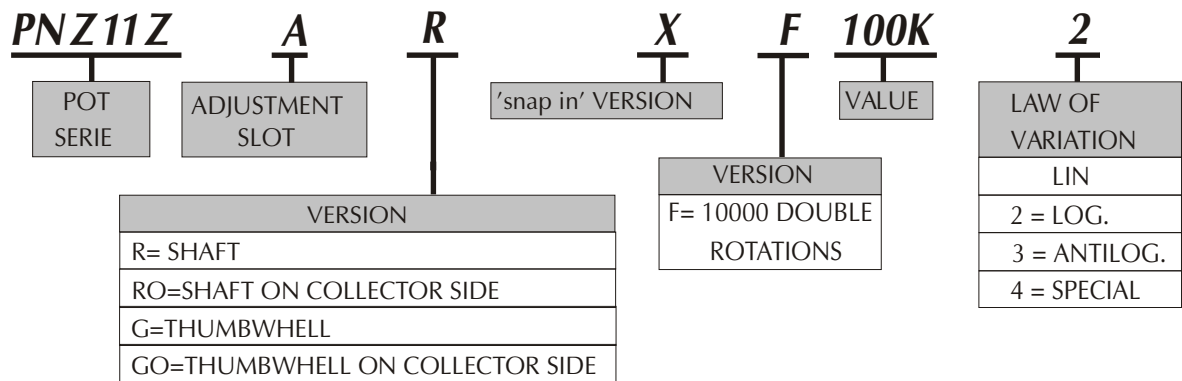
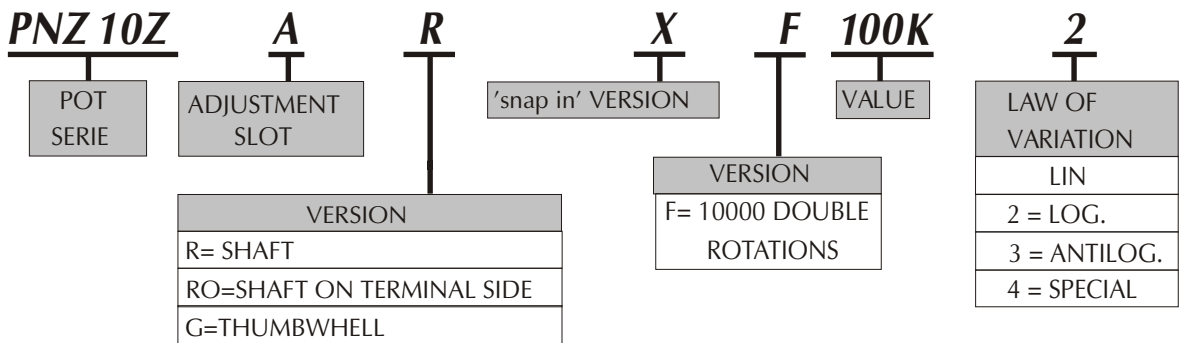

We reserved the right to alter without notice the specification, design, price or conditions of supply of any product or service. No liability is assumed as a result of their use or application.